

SBC-5180 DUAL BATTERY ISOLATOR

For Charging Auxiliary Batteries - 12V Systems Only

Option 1: ELECTRONIC DUAL BATTERY ISOLATOR

12V System - 80 Amp Capacity

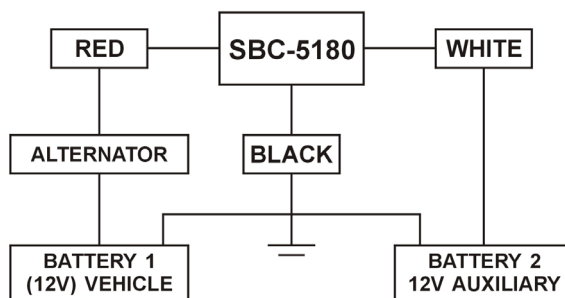

Option 2: ELECTRONIC CONTROL MODULE

12V System - Greater than 80 Amp Capacity

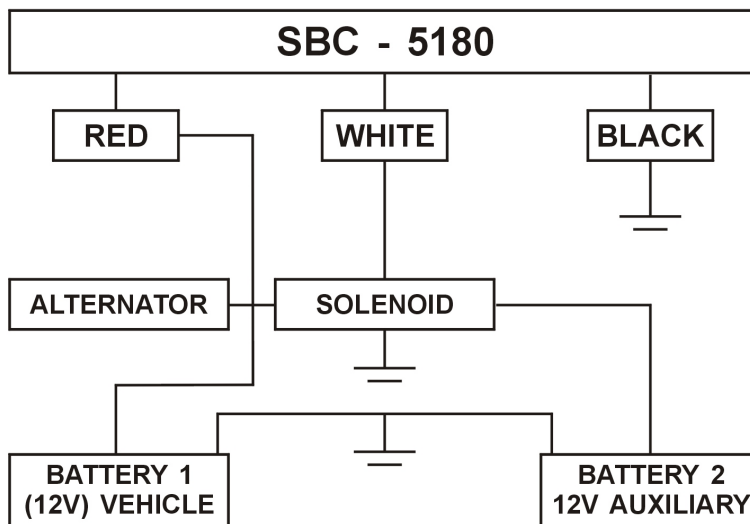

*Use a solenoid or relay of choice to give greater than 80 Amp capacity
eg.12V100A continuous duty solenoid or heavy duty relay*

General Features

- Charging LED indicator
- Switches ON 13.4V
- Switches OFF 12.6V
- Adjustable voltage
- Weather resistant