

SSP-9081

REMOTE PROGRAMMABLE POWER SUPPLY WITH ETHERNET NETWORK CONNECTIVITY DC WAVE FORM GENERATOR AUTO-SELECT VOLTAGE & CURRENT RANGES

USER MANUAL

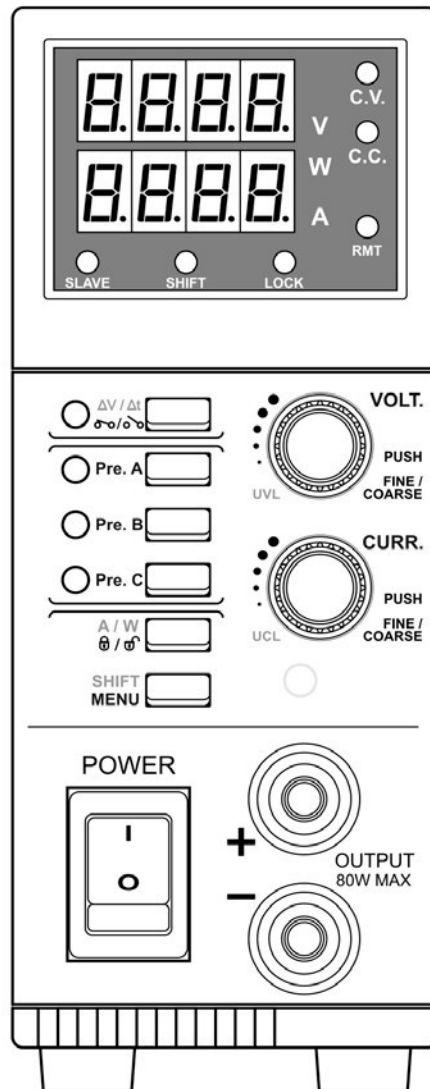

Table of Contents

1. PRECAUTIONS	3
1.1 WARNING	3
1.2 CAUTION	3
1.3 Operation environmental condition	3
2. ACCESSORIES	4
3. INTRODUCTION	4
4. SPECIFICATIONS	5
5. INDICATORS and CONTROLS	6
5.1 Display and Indications	6
5.2 Control Buttons and Knobs	7
5.3 Back Panel	8
6. OPERATION PROCEDURES	8
6.1 Adjusting Output Voltage and Current	8
6.2 Upper Voltage and Current Limit adjustment	9
6.3 Select and adjust 3 preset value of Voltage and Current	10
6.4 Output ON / OFF (Include power up ON / OFF setting)	10
6.5 Lock / Unlock of front panel	10
6.6 Watt meter and Amp meter selection	10
6.7 Ramp Up / Ramp Down generator	11
6.8 Master / Slave configuration	15
6.9 Factory reset	16
6.10 Remote control interface selection	16

1. PRECAUTIONS

Keep this manual in a safe place for quick reference at all times.

This manual contains important safety and operation instructions for correct use of the power supply. Read through the manual and pay special attention to the markings and labels of this unit and equipment to be connected.

Pay special attention to these two types of notices used in this manual

1.1 WARNING:

Failure to observe this warning may cause injury to persons and damage to power supply or connected equipment.

1. Do not use this power supply near water.
2. Do not operate or touch this power supply with wet hands.
3. Do not open the casing of the power supply when it is connected to ac mains.
4. Refer all servicing to qualified service personnel only.
5. Before replacing the AC fuse find out and clear up the cause first.
6. Replace the AC fuse with the same type and rating as the original fuse.

1.2 CAUTION:

Failure to observe this warning may result in damage to equipment and Improper functioning of the power supply.

1. Use a grounded 3 pin AC source.
2. This unit is for indoor use only.
3. Do not operate or place this unit in a humid, dusty, in direct sunlight location or near any heat source.
4. Before plugging into local AC mains, check with the rating label at the back of the unit.
5. Do not block any ventilation openings of the unit.
6. This unit must be used within the specified rating, regular excessive continuous over loading may cause damage to the power supply.
7. The gauge size of input power cable must be at least 0.75mmsq and the total length of power cable must not exceed 3m.
8. Input Fuse Recommended: T2AL250V (Time-Lag from 2A)

1.3 Operation environmental condition:

10-80% R.H.

Altitude up to 2000m

Installation category : CAT 2

Pollution degree : 2

Mains supply voltage fluctuation up to $\pm 10\%$ of the specified operating voltage.

2. ACCESSORIES



AC power cord

CDROM include user manual,
USB driver and PC control software



Output cable
with right angle safety plug
and crocodile clip



Master / Slave
connection cable



USB cable



Terminator for
Master/ Slave connection

3. INTRODUCTION

This Remote Programmable Constant Power SMPS with DC wave forms & Optional Ethernet Card. This multi-function constant power laboratory grade power supply is capable of generating various DC wave forms. A micro-processor is used for such DC waveform. There are 10 voltage generators which can either be panel programmed or by PC via remote control port. Remote Programming of repetitive cycling, control, monitoring and data logging can be done via the USB port. With optional Ethernet card it is capable of Internet connectivity and control, monitor, data log over 250 supplies by one PC. Application software of cyclic program, command sets, and Labview Drivers are provided. As a 80W Constant Power laboratory grade power supply it has an automatic range of 0.5-36V and 0 -5A. The maximum limits of current & voltage are calculated by $I_{max} \times V_{max} = 80W$. Its operation voltage and current spectrum is larger than 3 conventional power supplies of the same power rating. The power supply is ideal for R&D laboratory, burn in test especially for devices where the effect of irregular DC wave forms are important. Master & Slave configuration with SSP-9080 and SSP-9081 for parallel connection of multiple units up to 30 Units.

4. SPECIFICATIONS

Models	SSP-9081
Input Voltage Range	100 – 240VAC
No Load Input Current at 230VAC	≤150mA
Full Load Input Current at 230VAC	≤500mA
AC input Frequency	50 – 60 Hz~
Efficiency	≥78%
Power Factor	≥0.9
Constant Voltage and Current Range Selection:	
0.5-36V / 0-5A	Auto range with maximum output power 80W ($V \times A \leq 80W$)
Constant Voltage Characteristics:	
Adjust Resolution	10mV
Load Regulation (10 – 90%)	≤30mV
Line Regulation (±10%)	≤4mV
Ripple & Noise (peak-peak)	≤35mA
Constant Current Characteristics:	
Adjust Resolution	10mA
Load Regulation (10 – 90%)	≤10mA
Line Regulation (±10%)	≤10mA
Voltmeter & Ammeter Accuracy	±(0.5% +5counts)
User adjustable upper current & voltage limit	Yes
Number of preset recalls of frequent use V&I setting	3
Remote Sensing	Yes
Ramp Step Irregular Waveform functions	
Number of Voltage Level Setting	10
Settable Output Time Period of each Voltage Level	0 to 1200 seconds
Remote Programmable / Control by PC	Output ON/OFF, Voltage & Current Control, Selection of Voltage and Current Preset, Programmable of cyclic output and data logging of output, Upper Voltage & Current Limit control.
Protection	Tracking Over Voltage Protection, Current Limiting Protection, Short Circuit, Overload, Over Temperature, Upper Voltage Limit, Upper Current Limit.
Standard Communication Port	USB 2.0
Optional Interface	Ethernet, Factory or User install
Additional Function	Master/Slave Control
Cooling Method	Natural Convection
Dimensions (WxHxD)	53.5x127x330mm 2x5x13 inch
Weight	Approx. 1.9kgs 4.2lbs



□ All values are based on the Standard ambient Temperature 25°C and Pressure 0.1Mpa.

□ SPECIFICATIONS ARE SUBJECT TO CHANGE WITHOUT PRIOR NOTICE

5. INDICATORS AND CONTROLS

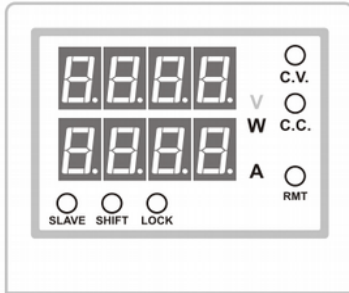
5.1 Display and Indications



<input type="radio"/> C.V.	Constant Voltage Mode Indicate the Power Supply is working in Constant Voltage mode. The output voltage of power supply is remains constant at the set voltage in this mode. The power supply will be working in this mode while the loading current is least than the set current.
<input type="radio"/> C.C.	Constant Current Mode Indicate the Power Supply is working in Constant Current mode. The output current of power supply is remains constant at the set current provided that the loading is sufficient to draw current equal to or larger than set current.
W	Watt-meter Indicate the lower part 4 digits LED is watt-meter. The value is showing output power.
A	Amp-meter Indicate the lower part 4 digits LED is watt-meter. The value is showing output power.
<input type="radio"/> RMT	Remote Control Indicate the Power Supply is under remote control. Whenever you connection power supply using control software through USB or Ethernet. This LED will be ON.
<input type="radio"/> SLAVE	SLAVE Indicate the Power Supply is in slave mode and control by master unit. The voltage and current setting of slave units are being set to value of master unit. The button and knob of slave units are being locked. All the adjustment should be done in master unit. (Details refer to Factory reset section)
<input type="radio"/> SHIFT	SHIFT Indicate the Shift key is pressed and the second function of buttons will be used. The second function of buttons include $\Delta V/\Delta t$, A/W, UVL, UCL
<input type="radio"/> LOCK	LOCK Indicate the panel of power supply is being locked. This LED will being ON in 2 conditions. The first is manually press  /  button. The other condition is the power supply is under remote control.

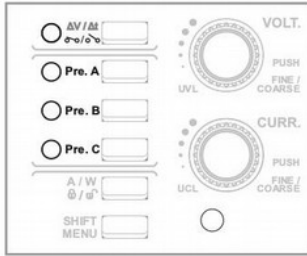

	Output ON/OFF or Ramp UP/Ramp Down program running This LED has two indications. a. When it is solid ON, it indicate output ON/OFF status. b. When it is Flashing, it indicate ramp up/ramp down program is running (Refer to Ramp Up / Ramp Down generator section)
	Preset A Indicate Preset A is selected, the output voltage and current will set preset A value.
	Preset B Indicate Preset B is selected, the output voltage and current will set preset B value.
	Preset C Indicate Preset C is selected, the output voltage and current will set preset C value.

5.2 Control Buttons and Knobs

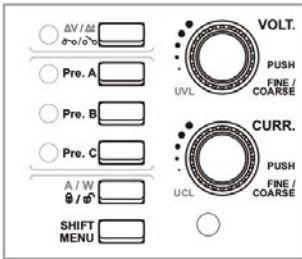

The power supply has 2 knobs and 6 buttons.

	Voltage adjust knob
	Current adjust knob
	Output ON / OFF button
	Preset program A selection button
	Preset program B selection button
	Preset program C selection button
	LOCK / UNLOCK button
	Menu button

5.3 Back Panel

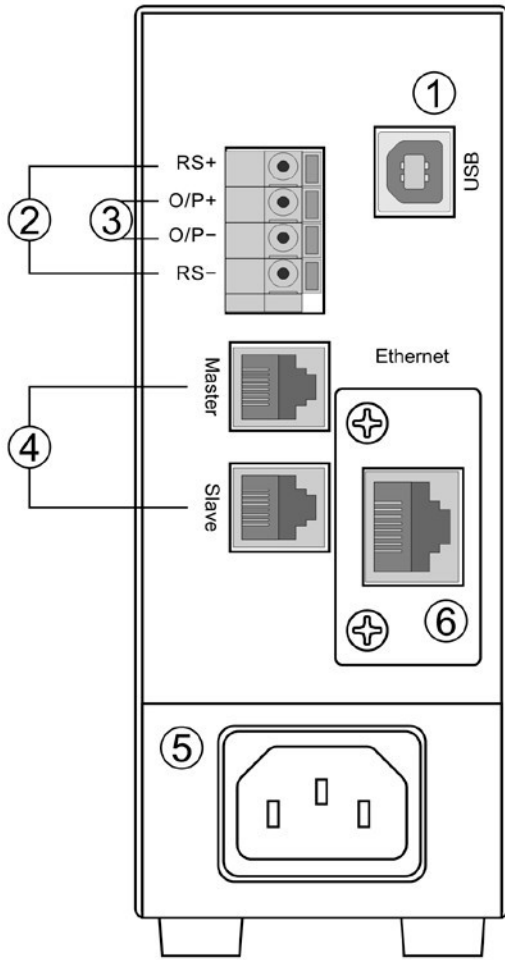

- ① USB communication port
- ② Remote sensing terminals
- ③ DC output terminal which has same power rating as the front output
- ④ Master/Slave connection
- ⑤ AC INPUT SOCKET
- ⑥ ETHERNET port (Optional)

6. OPERATION PROCEDURES

6.1 Adjusting Output Voltage and Current

Adjust Output Voltage:

	<p>Rotate Voltage Knob clockwise to INCREASE output voltage Rotate Voltage Knob anti-clockwise to REDUCE output voltage Press Voltage knob to switch between COARSE and FINE adjustment. When press the knob the digit will be high-lighted for adjust.</p>
--	---

Adjust Output Current:

	<p>Rotate Current Knob clockwise to increase output voltage Rotate Current Knob anti-clockwise to reduce output voltage Press Current knob to switch between COARSE and FINE adjustment. When press the knob the digit will be high-lighted for adjust. Upper Voltage and Current Limit adjustment</p>
--	---



6.2 Upper Voltage and Current Limit adjustment

Upper Voltage Limit (UVL)

The Upper Voltage Limit is feature to let user to set maximum value for voltage adjustment. This feature can help to prevent accidentally adjust to very high output voltage to cause damage on object under testing. During increasing output voltage and hit the UVL, the display will show you alert as follow;



Adjust Upper Voltage Limit:

- The second function of Voltage Knob is for UVL adjustment.
- Press  and  LED will ON.
- Then press Voltage Knob. The display will show as follow;



- Rotate Voltage Knob to adjust the value.
- Press  to confirm setting. If the new UVL value is lower than set voltage, it will show UVL Error alert.

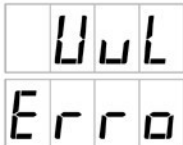



Just reduce the set voltage to lower than the UVL value. Then the UVL Error will OFF.

Upper Current Limit (UCL)

The Upper Current Limit is feature to let user to set maximum value for current adjustment. This feature can help to prevent accidentally to set load current too high to damage on object under test. During increasing output current and hit the UCL, the display will show you alert as follow;



Adjust Upper Current Limit:

- The second function of Current Knob is for UCL adjustment.
- Press  and see  LED ON
- Then press Current Knob. The display will show as follow;



- Rotate Current Knob to adjust the value.
- Press  to confirm setting. If the new UCL value is lower than set current, it will show UCL Error alert.

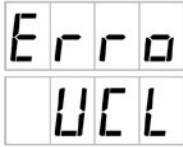

Just reduce the set current to lower than the UCL value. Then the UCL Error will OFF.

6.3 Select and adjust 3 preset value of Voltage and Current

This power supply has 3 preset program of Voltage and Current value for quick recall to use. To selection preset program, just press Pre1/ Pre2/ Pre3. To adjust value of preset program. After preset program is selected, use Voltage and Current knob to adjust value for that preset program. The setting will be saved automatically. The value can be reset to factory default in menu. (See Factory reset section)





6.4 Output ON/OFF (include power up ON/OFF setting)

The power has feature to switch output ON/ OFF by pressing  button. The LED will ON when the output is ON. The display will show the actual output value of voltage and current/watt.

Change Power Up output ON/OFF setting

The power up output ON/ OFF status can be configured according to usage requirement. The default setting is output OFF when system power up. It has option to set as SAME AS LAST STATUS. That means the output ON/ OFF status will same as status before power off.

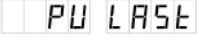
Steps to change setting;

- Step 1 - Press and hold  to enter menu
- Step 2 - Rotate Volt. Knob to select PU menu. The display shows 
- Step 3 - Press Volt. Knob to enter PU setting. The display show 
- Step 4 - Rotate Curr. Knob to change setting to . The output is set to as same as last status.
- Step 5 - Press Volt. Knob to confirm.
- Step 6 - Press  to exit menu



6.5 Lock/ Unlock of front panel

In case the front panel is locked, only the  has function. Other buttons and knobs are being locked. The front panel will be locked in two conditions.

- Manually press  to LOCK the front panel.
- The unit is under remote control by PC through USB or Ethernet.

6.6 Watt-meter and Amp-meter selection

The lower part of 4 digit display can use as Watt-meter or Amp-meter. It can switch anytime.

- Press  and see  LED ON
- Press  to switch between Watt-meter and Amp-meter. W and A LED will ON alternatively.

6.7 Ramp Up/ Ramp Down generator

The SSP-9081 has function to generate waveform with ramp up and ramp down. It allow to set 10 steps for wave.

Steps to setup ramp up/ramp down wave;

Step 1 - Press and hold  to enter menu

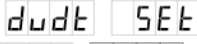

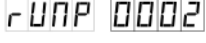

Step 2 - Rotate Volt. Knob to select dvdt menu. The display shows 

Step 3 - Press Volt. Knob to enter dvdt setting. The display show 

Step 4 - Rotate VOLT. Knob to set items.

Step 5 - Rotate Curr. Knob to change value of set items

The below table shows the available set items and value range for dvdt menu.



Set Item	Description	Value Range
	Number of steps to be use for wave form generation. Must start from step 1.	2-10
	Number of cycle to run for wave form	0 to 999 0 means run forever
	Step 1 to Step 10 Voltage setting (in V)	0 to 36V
	Step 1 to Step 10 run time length (in S)	0 to 1200s

Step 6 - Press Volt. Knob to confirm and exit.

Step 7 - Press  to exit menu.

Steps to Run ramp up/ramp down wave;

Step 1 - Press  to switch on output

Step 2 - Press  and see  LED ON.

Step 3 - Press  to run dvdt program.

Examples,

Example 1 – Triangular Waveform.



Setting value

Set Item	Value	Explanation
<code>rUNP</code>	2	Set 2 steps to run. Step 1 and Step 2
<code>rUNT</code>	3	Run 3 cycle only
<code>PO1V</code>	2.5	Set Step 1 voltage to 2.5V
<code>PO1t</code>	3	Set Step 1 run time to 3s (Ramp UP from step 1 voltage to step 2 voltage in 3s)
<code>PO2V</code>	12	Set Step 2 voltage to 12V
<code>PO2t</code>	3	Set Step 2 run time to 3s (Ramp DOWN from step 2 voltage to step 1 voltage in 3s)

Example 2 – Saw-tooth waveform



Setting value

Set Item	Value	Explanation
<code>rUNP</code>	2	Set 2 steps to run. Step 1 and Step 2
<code>rUNT</code>	6	Run 6 cycle only
<code>PO1V</code>	2.5	Set Step 1 voltage to 2.5V
<code>PO1t</code>	3	Set Step 1 run time to 3s (Ramp UP from step 1 voltage to step 2 voltage in 3s)
<code>PO2V</code>	12	Set Step 2 voltage to 12V
<code>PO2t</code>	0	Set Step 2 run time to 0s (Edge DOWN from step 2 voltage to step 1 voltage in 0s)

Example 3 – Rectangular Waveform

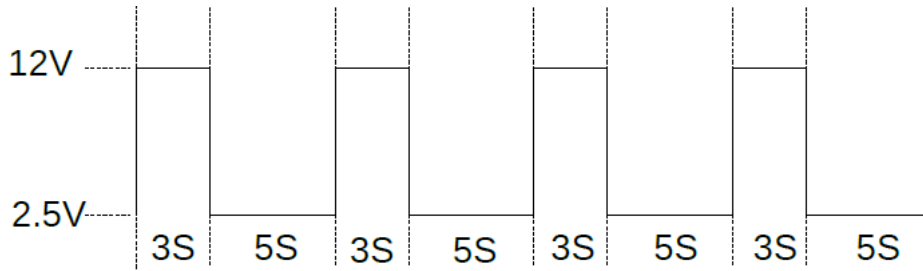

Setting value

Set Item	Value	Explanation
<code>rUNP</code>	4	Set 4 steps to run. From step 1 to step 4
<code>rUNT</code>	4	Run 4 cycle only
<code>P01V</code>	2.5	Set Step 1 voltage to 2.5V
<code>P01t</code>	0	Set Step 1 run time to 0s (Edge UP from step 1 voltage to step 2 voltage in 0s)
<code>P02V</code>	12	Set Step 2 voltage to 12V
<code>P02t</code>	3	Set Step 2 run time to 3s (Keep at 12V by 3s, since step 2 voltage = step 3 voltage)
<code>P03V</code>	12	Set Step 3 voltage to 12V
<code>P03t</code>	0	Set Step 3 run time to 0s (Edge DOWN from step 3 voltage to step 4 voltage in 0s)
<code>P04V</code>	2.5	Set Step 4 voltage to 2.5V
<code>P04t</code>	5	Set Step 4 run time to 5s (Keep at 2.5V by 5s, since step 4 voltage = step 1 voltage)

Example 4 – irregular waveform

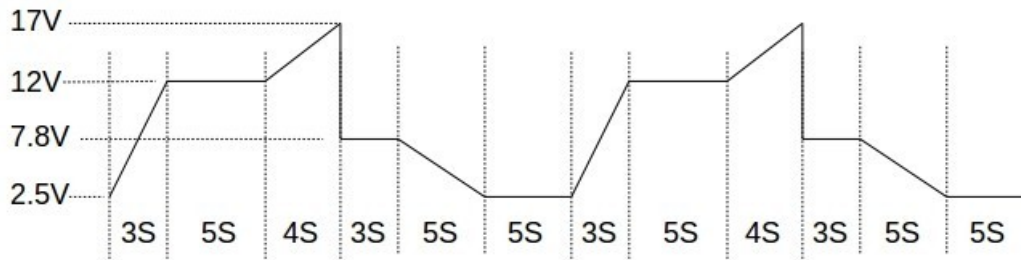

Setting value

Set Item	Value	Explanation
<code>rUNP</code>	7	Set 7 steps to run. From Step 1 to Step 7
<code>rUNt</code>	0	Run forever
<code>P01v</code>	2.5	Set Step 1 voltage to 2.5V
<code>P01t</code>	3	Set Step 1 run time to 3s (Ramp UP from step 1 voltage to step 2 voltage in 3s)
<code>P02v</code>	12	Set Step 2 voltage to 12V
<code>P02t</code>	5	Set Step 2 run time to 5s (Keep at 12V by 5s, since step 2 voltage = step 3 voltage)
<code>P03v</code>	12	Set Step 3 voltage to 12V
<code>P03t</code>	4	Set Step 3 run time to 4s (Ramp UP from step 3 voltage to step 4 voltage in 4s)
<code>P04v</code>	17	Set Step 4 voltage to 17V
<code>P04t</code>	0	Set Step 4 run time to 0s (Edge DOWN from step 4 voltage to step 5 voltage in 0s)
<code>P05v</code>	7.8	Set Step 5 voltage to 7.8V
<code>P05t</code>	3	Set Step 5 run time to 3s (Keep at 7.8V by 3s step 5 voltage = step 6 voltage)
<code>P06v</code>	7.8	Set Step 6 voltage to 7.8V
<code>P06t</code>	5	Set Step 6 run time to 5s (Ramp DOWN from step 6 voltage to step 7 voltage in 5s)
<code>P07v</code>	2.5	Set Step 7 voltage to 2.5V
<code>P07t</code>	5	Set Step 7 run time to 5s (Keep at 2.5V by 5s, since step 7 voltage = step 1 voltage)

6.8 Master/ Slave configuration

The SSP-9080 and SSP-9081 can be configured for Master/ Slave connection. When systems are connected in Master/Slave, the Slaves' output will follow the setting of Master.

The set voltage will same for Master and all Slave system. The load current will share over all units. That means 10Amp share to 5 units will make every unit carry 2Amp.

Every units in same Master/Slave connection should assign an unque address ID. The Master unit should be address ID 0(factory default). The Slave address can be from 1 to 30.

Steps for Changing the address ID;

Step 1 – Press and hold  button to enter setting menu.

Step 2 – Rotate VOLT. knob to select address menu. The display shows 

Step 3 – Press VOLT. knob to enter address menu.

Step 4 – Rotate CURR knob to change address ID.

Step 5 – Press VOLT. knob to confirm.

Step 6 – Press  to exit menu.

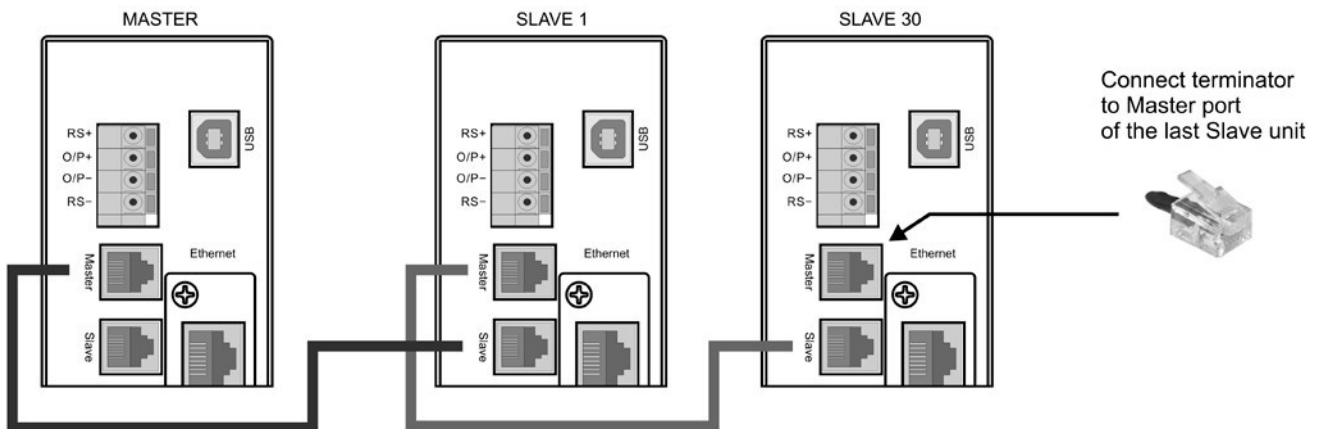
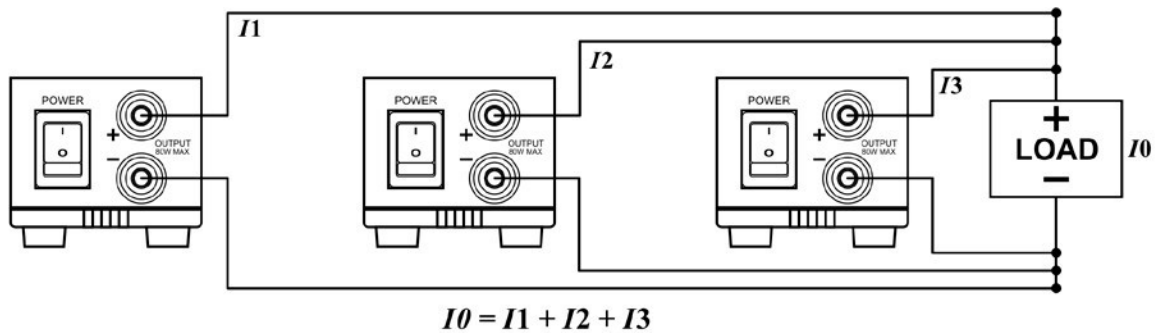

6.9 Factory reset



The Factory reset feature is reset the Preset program, UVL, UCL to factory default setting.

Steps for Factory reset;

Step 1 – Press and hold  button to enter setting menu.

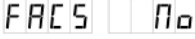
Step 2 – Rotate VOLT. knob to select factory reset menu. The display shows 

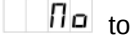
Step 3 – Press VOLT. knob to enter address menu. The display shows 

Step 4 – Rotate CURR knob to change from  to 

Step 5 – Press CURR. knob to reset unit.

The power will reset immediately.

6.10 Remote control interface selection

The SSP-9081 bundles with USB port for remote control. The Ethernet Card is optional accessory. The remote control interface can be selected in menu.

Steps for Remote Control interface selection;

Step 1 – Press and hold  button to enter setting menu.

Step 2 – Rotate VOLT. knob to select UNS menu. The display shows 

Step 3 – Press VOLT. knob to enter UNS menu. The display shows 

Step 4 – Rotate CURR knob to change from  to  for Ethernet interface.

Step 5 – Press VOLT knob to confirm.

Step 6 - Press  to exit menu.

After configure the interface of SSP-9081, run Manson Power Supply Control Software in Windows PC. Please refer to software user manual in CD or Manson website for detail usage.